

Data Sheet

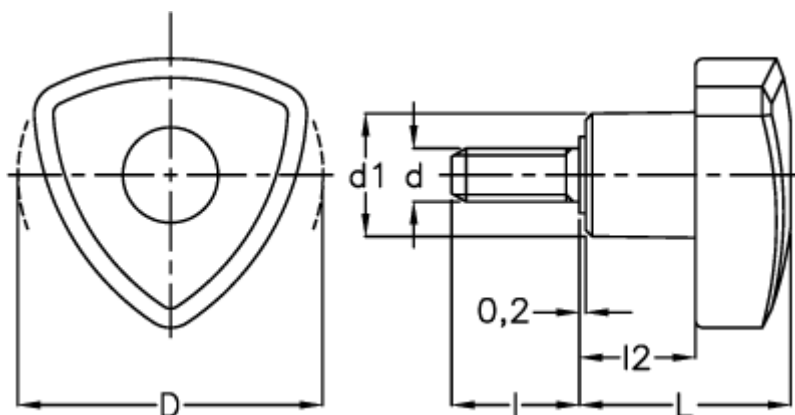

Article number: 2302083043
Description: E+G Lock knob
VTR.32 p-M5x40

Measures



d	=	32
d1	=	14
d 6g	=	M5
l	=	40
L	=	26
l2	=	16